

KASTENFENSTER - LÖSUNGEN IM DETAIL

| 1

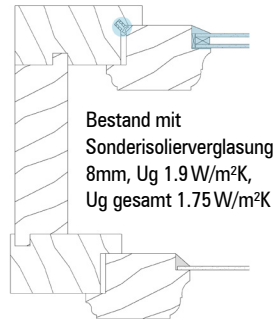

| 2



| 3

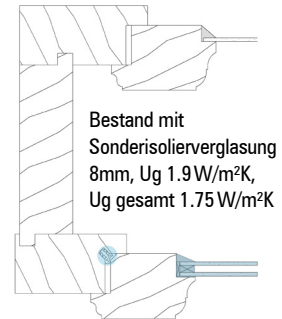

| 4

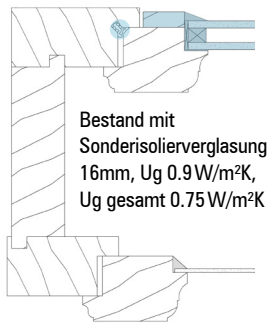

| 5

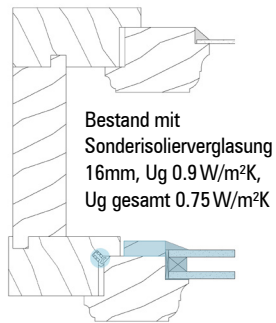

| 6

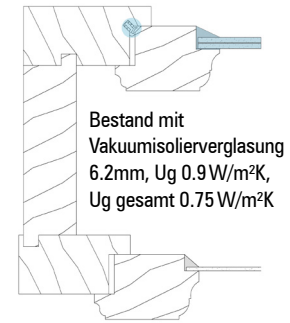

| 7

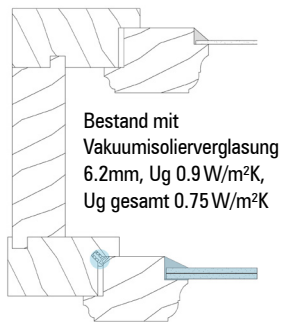

| 8

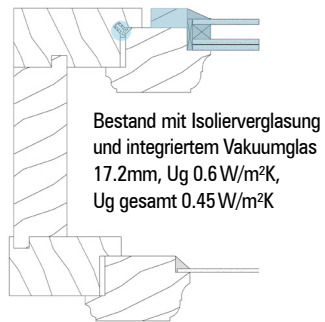

| 9

